

Baker Bedford

210cm EXT Dining Table(Product Code SF07)

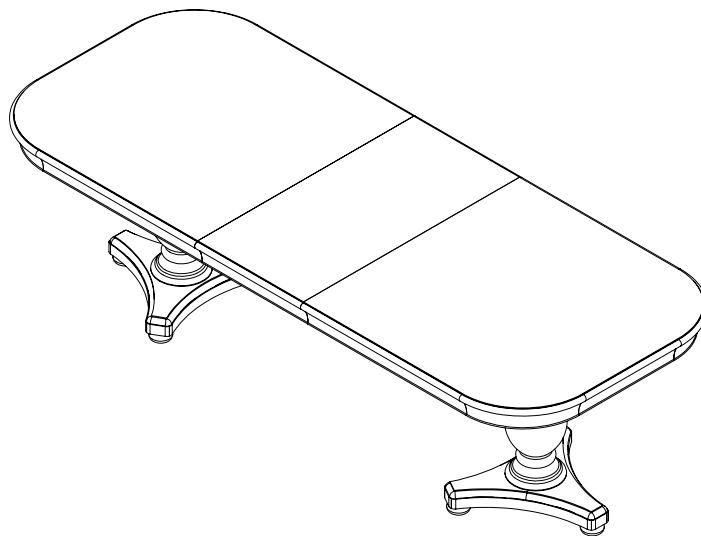





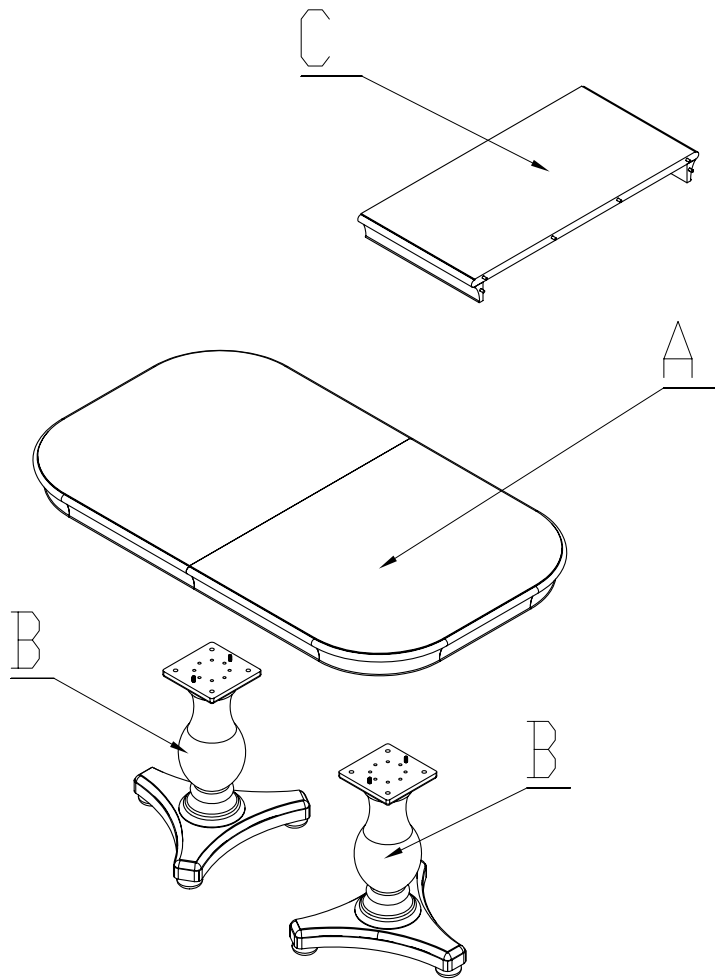

Step By Step Assembly Instructions

Pre-Assembly Preparation

1. Please check the pack contents before attempting to assemble this product. A full checklist of components is given in this leaflet. If any components are missing, please contact the retailer from whom you bought this product.
2. This product is HEAVY, it should be assembled as near as possible to the point of use. TAKE CARE WHEN LIFTING to avoid personal injury and (or) damage to the product.
3. This product takes approximately 1 HOUR to assemble with 3 PEOPLE.
4. The fitting pack contains SMALL ITEMS which should be KEPT AWAY FROM YOUNG CHILDREN.
5. Read this leaflet in full before commencing assembly.
6. You should lay a PROTECTIVE CLOTH on the floor BEFORE commencing assembly.



A	Table Top	1	B	Pedestal	2	C	Extension Leaf	1
D	Allen Key 	1	E	Bolt 	8	F	Nuts 	16
G	Flat Washer 	24	H	Split Washer 	16	I	Spanner 	1

Step 1 -Locate the plinth onto the post by using eight nut(F),eight flat washer(G) and eight split washer(H).Then locate the bun feet onto the plinth as shown.

Fittings



FX8



GX8



HX8

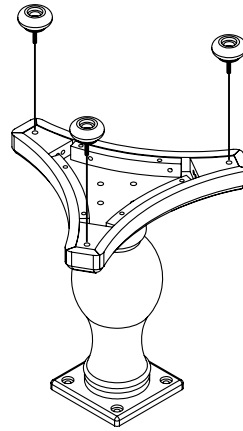
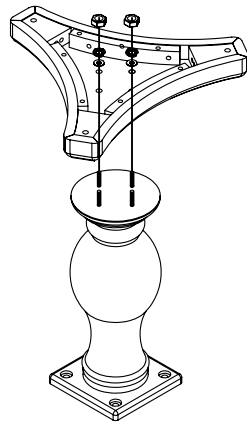

Step 2 -Put the table top upside down,locate the pedestals onto the underside of the table top.Align the legs as shown below.Ensuring that the dowels align to holes in the table top.

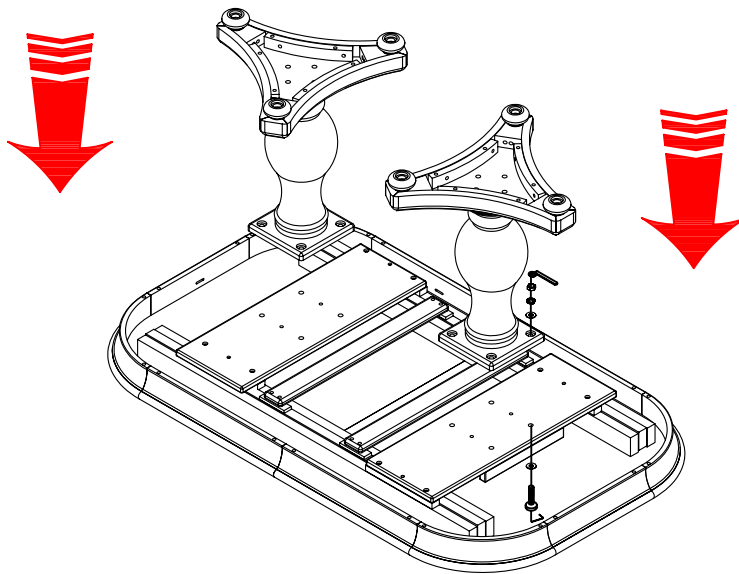

Step 3 -To secure the pedestals,use the eight bolts(E)inserted through the pilot holes down through the holes in the top of each pedestal together with the washers(G&H).Secure washers and nuts onto the bolts from the underside of the table and tighten all bolts using the Allen key and spanner provided.Secure the sliding table tops together,using the spring clips on the underside of the table.Refer to step 1 and step 4 for instructions on extending your table.

Fittings

-  EX8
-  FX8
-  GX16
-  HX8

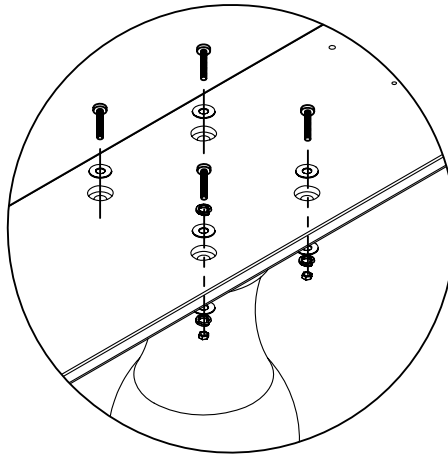

NOTE

This view is shown with the table top removed for clarify

Step 4 -To extend the table,firstly ensure that the spring clips on the underside of the table are undone and the table leaves are pulled apart to their maximum.Carefully lift the leaf from inside the table top and then fold the skirts down as shown in the diagram below.

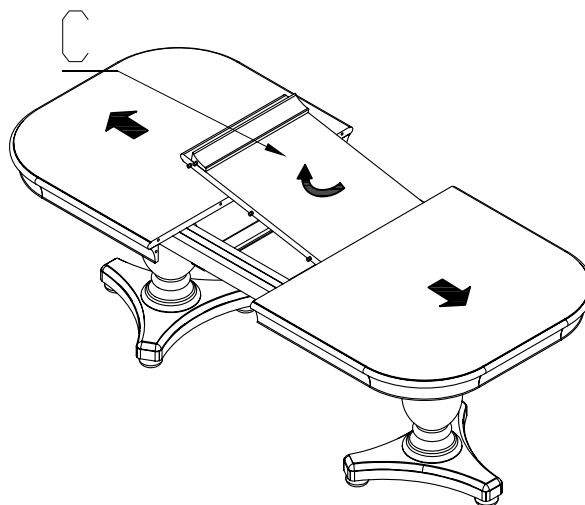

Step 5

-Locate the extension leaf between the table leaves. Fold down the skirts on the leaf as per the diagram below. Finally push the main leaves back together ensuring that the pins locate into the holes. Secure all tops together, using the spring clips on the underside of the table to remove the extension, simply perform the procedure in reverse, stowing the extension under the table top. The assembly now is completed.

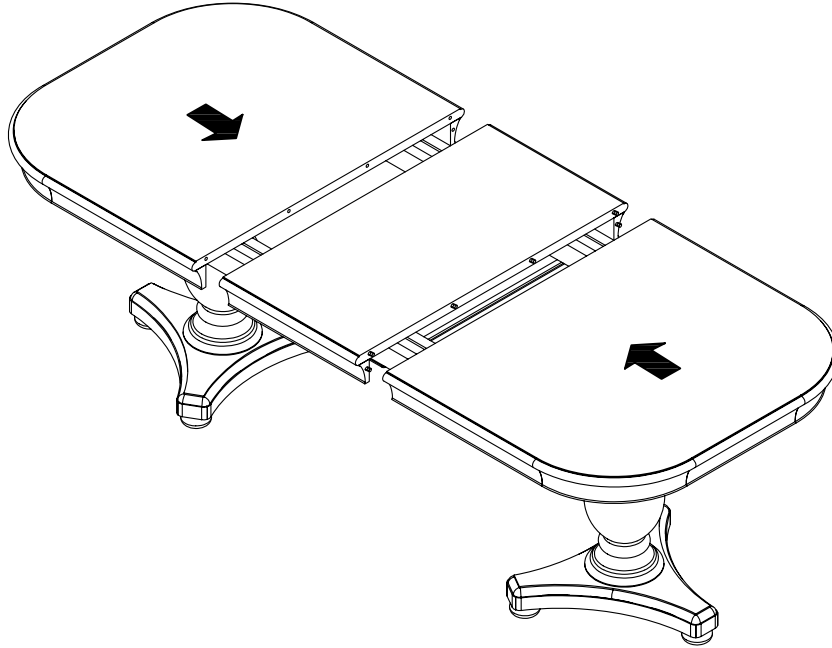



Stratford Products

(Product Code SF05, SF06, SF07, SF08, SF10, SF11, SF12, SF14, SF15, SF16, ST03, ST04, ST07, ST08, ST09, ST10, ST11, ST12, ST14, ST15, ST16, ST19)

Step By Step Assembly Instructions

1. The following steps should be carried out with the unit as close to the point of use as possible.
 2. With the aid of an assistant (if necessary) lay the chest onto its back .
 3. Screw the four feet up into the female inserts located on the underside of the unit.
 4. With all four feet securely fastened, return the unit into an upright position.
 5. When moving the unit to the point of use **IT MUST BE LIFTED.**
-

Baker Bedford

170cm EXT Dining Table(Product Code SF06)

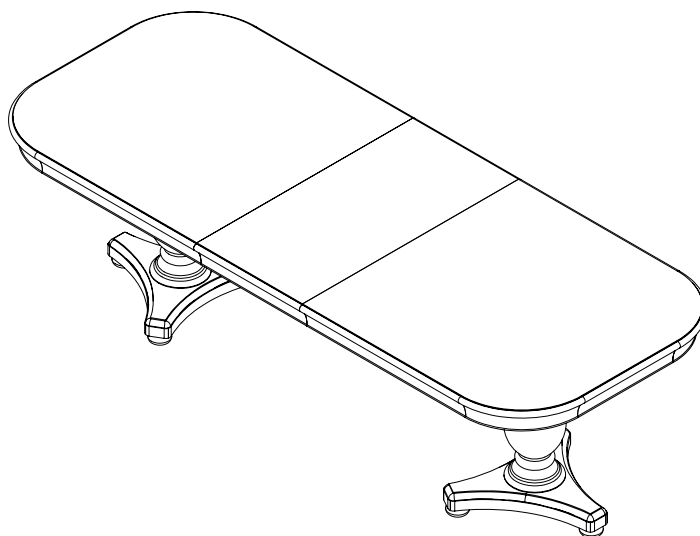





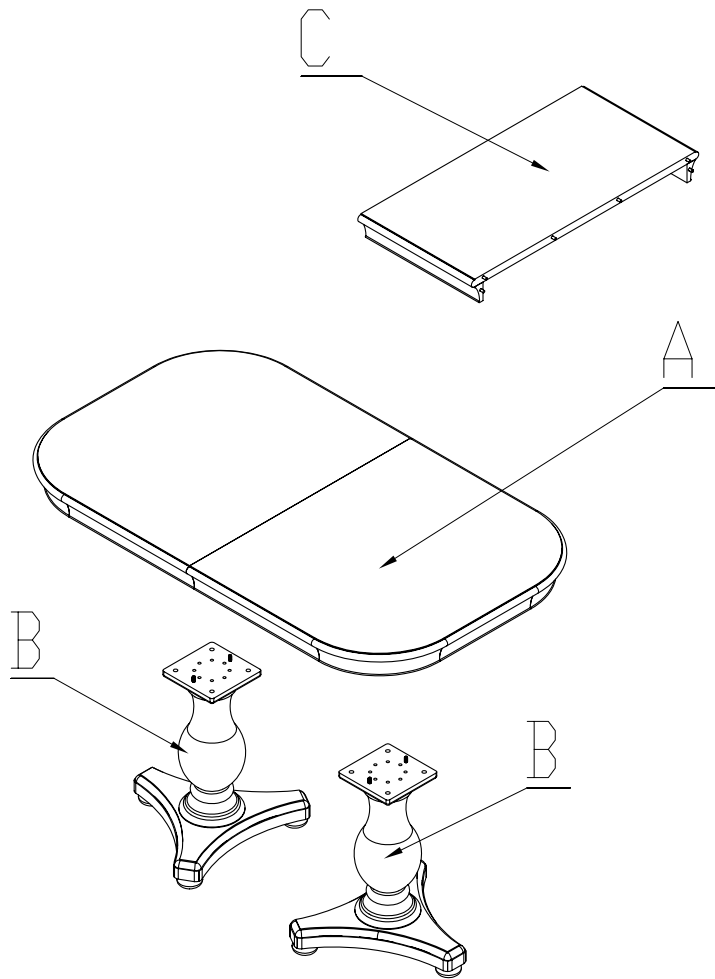

Step By Step Assembly Instructions

Pre-Assembly Preparation

1. Please check the pack contents before attempting to assemble this product. A full checklist of components is given in this leaflet. If any components are missing, please contact the retailer from whom you bought this product.
2. This product is HEAVY, it should be assembled as near as possible to the point of use. TAKE CARE WHEN LIFTING to avoid personal injury and (or) damage to the product.
3. This product takes approximately 1 HOUR to assemble with 3 PEOPLE.
4. The fitting pack contains SMALL ITEMS which should be KEPT AWAY FROM YOUNG CHILDREN.
5. Read this leaflet in full before commencing assembly.
6. You should lay a PROTECTIVE CLOTH on the floor BEFORE commencing assembly.



A	Table Top	1	B	Pedestal	2	C	Extension Leaf	1
D	Allen Key 	1	E	Bolt 	8	F	Nuts 	16
G	Flat Washer 	24	H	Split Washer 	16	I	Spanner 	1

Step 1 -Locate the plinth onto the post by using eight nut(F),eight flat washer(G) and eight split washer(H).Then locate the bun feet onto the plinth as shown.

Fittings



FX8



GX8



HX8

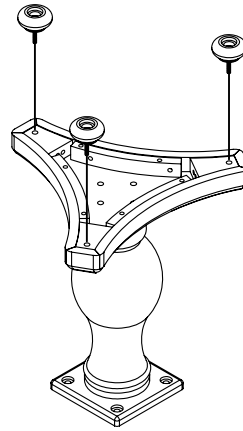
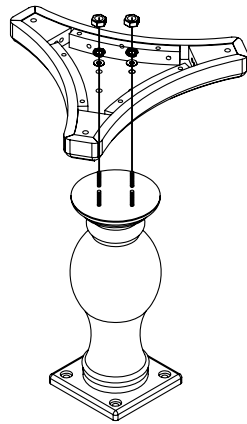

Step 2 -Put the table top upside down,locate the pedestals onto the underside of the table top.Align the legs as shown below.Ensuring that the dowels align to holes in the table top.

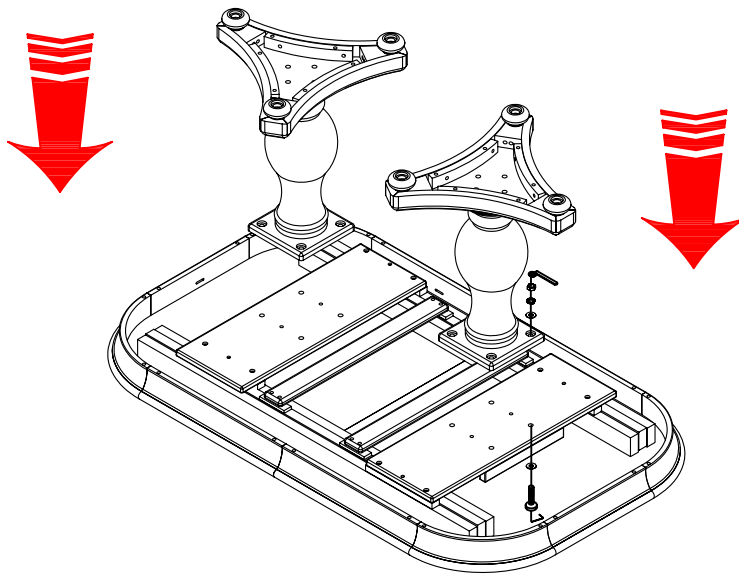

Step 3 -To secure the pedestals,use the eight bolts(E)inserted through the pilot holes down through the holes in the top of each pedestal together with the washers(G&H).Secure washers and nuts onto the bolts from the underside of the table and tighten all bolts using the Allen key and spanner provided.Secure the sliding table tops together,using the spring clips on the underside of the table.Refer to step 1 and step 4 for instructions on extending your table.

Fittings

-  EX8
-  FX8
-  GX16
-  HX8

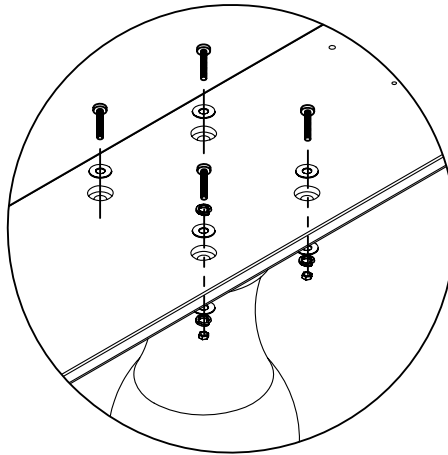

NOTE

This view is shown with the table top removed for clarify

Step 4 -To extend the table,firstly ensure that the spring clips on the underside of the table are undone and the table leaves are pulled apart to their maximum.Carefully lift the leaf from inside the table top and then fold the skirts down as shown in the diagram below.

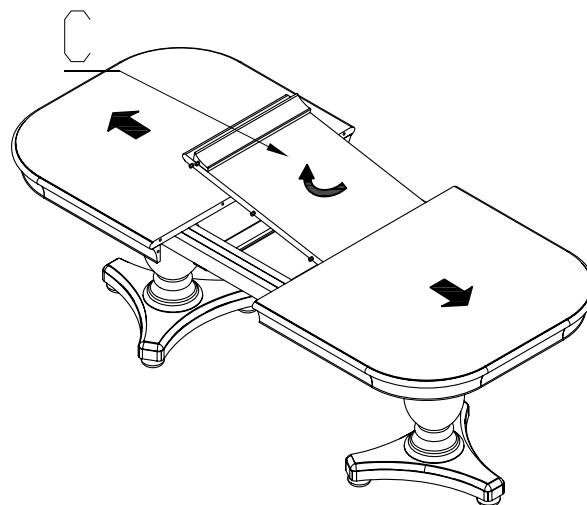

Step 5

-Locate the extension leaf between the table leaves. Fold down the skirts on the leaf as per the diagram below. Finally push the main leaves back together ensuring that the pins locate into the holes. Secure all tops together, using the spring clips on the underside of the table to remove the extension, simply perform the procedure in reverse, stowing the extension under the table top. The assembly now is completed.

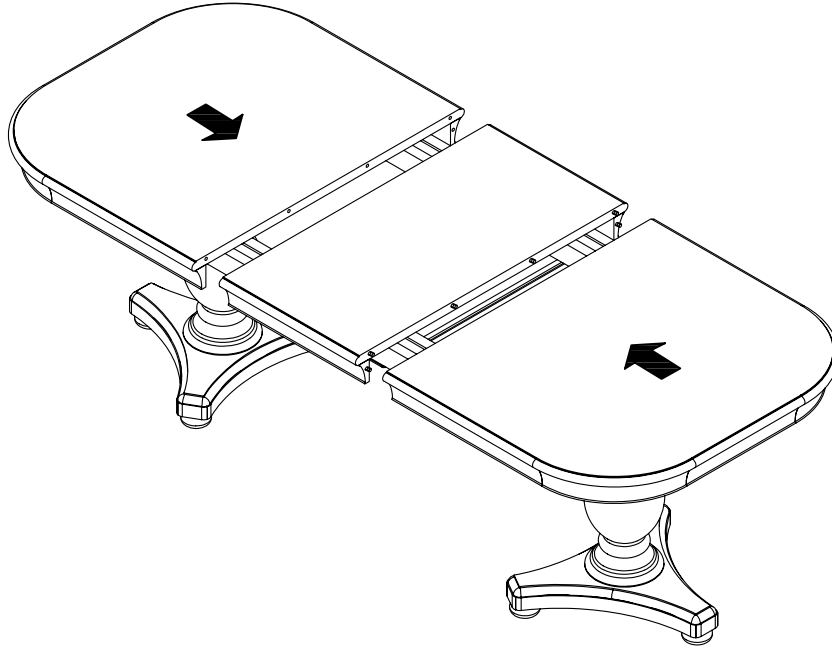



Stratford Products

(Product Code SF05, SF06, SF07, SF08, SF10, SF11, SF12, SF14,
SF15, SF16, ST03, ST04, ST07, ST08, ST09, ST10, ST11, ST12, ST14
ST15, ST16, ST19)

Step By Step Assembly Instructions

1. The following steps should be carried out with the unit as close to the point of use as possible.
 2. With the aid of an assistant (if necessary) lay the chest onto its back .
 3. Screw the four feet up into the female inserts located on the underside of the unit.
 4. With all four feet securely fastened, return the unit into an upright position.
 5. When moving the unit to the point of use **IT MUST BE LIFTED.**
-